

PS-E Series, PS Series SPELA™ 300 Bellows Pump

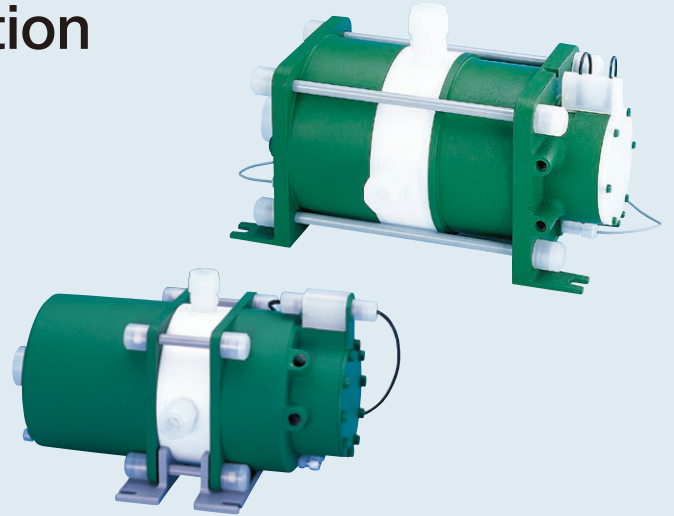

Built-in accumulation function enables the pump itself to achieve low pulsation



Low pulse pressure

The PS-E and PS series bellows pumps incorporate an accumulation function that enables the pump itself to reduce pulse pressure.

High-quality bellows

The PS-E and PS series bellows pumps employ special PTFE bellows with excellent flex-fatigue resistance, and the bent portion of the bellows is rounded to achieve long service life.

Space saving and low cost

There is no need to install an accumulator separately, enabling compact and cost-saving design.

Pulse pressure curve

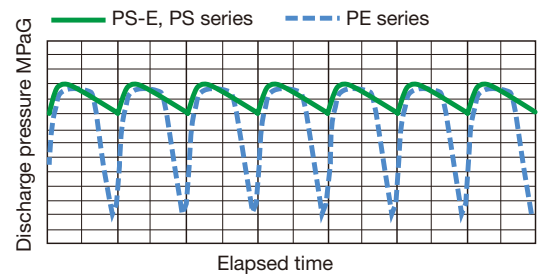

Shape of bent portion

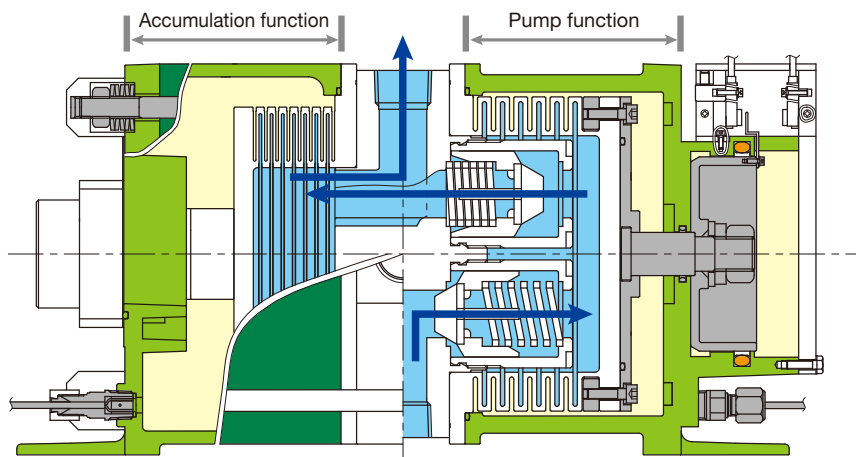
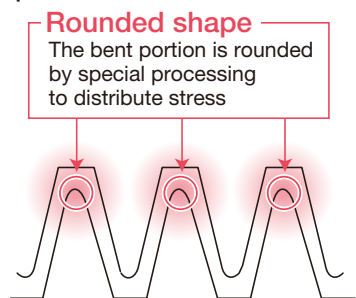

Top view

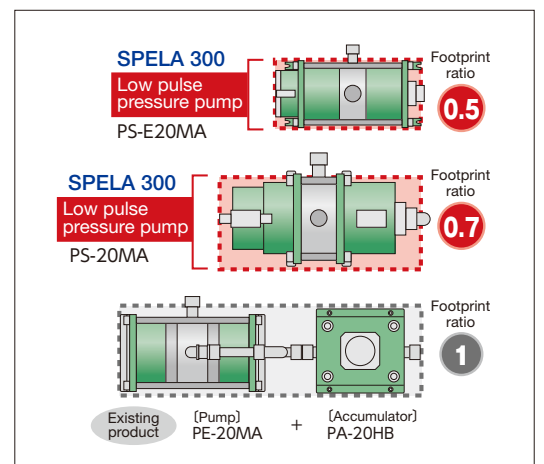

All wetted parts employ fluorocarbon polymers with excellent chemical resistance (PTFE or PFA).

For cleaning system circulation line

PS-E2MA, PS-E10MA, PS-E20MA, PS-E40MA

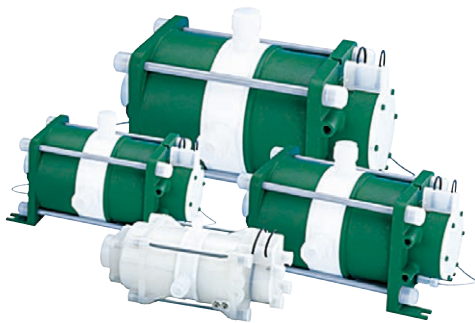

■ Dimensions

Unit: mm

	A	B	C	D	E	F	G	H	J	K	L	M
PS-E2MA	286	132	140	136	106	40	128	111	53	Rc1/8	4-M5 Thread length 7	Rc1/4
PS-E10MA	330	285	163	188	138	112	183	154	74	Rc1/4	4-φ10	Rc1/4
PS-E20MA	373	335	194	226	176	144	231	181	93	Rc1/4	4-φ12	Rc1/4
PS-E40MA	449	395	245	272	210	172	277	215	110	Rc3/8	4-φ14	Rc1/4

■ Structural drawings

PS-E2MA

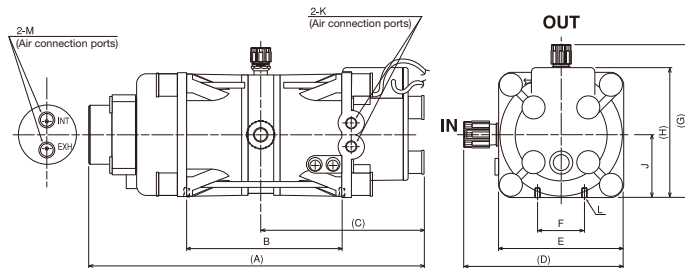

PS-E10MA, PS-E20MA, PS-E40MA

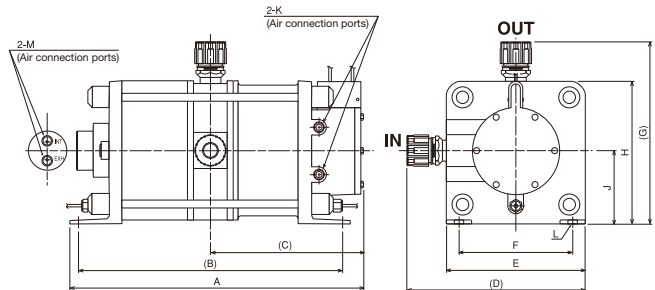

■ Specifications

Pump model		PS-E2MA	PS-E10MA	PS-E20MA	PS-E40MA
Pump connection size*1	mm	IN φ10 / OUT φ6	IN φ19 / OUT φ12	IN φ19 / OUT φ19	IN φ25 / OUT φ25
Pump connector		Super 300 Type Pillar Fitting™			
Max discharge capacity	L/min	3.0	10	20	40
Pulsation pressure range	When the pump discharge pressure is 0.1 MPaG or more	Within ±12.5%	Within ±16%	Within ±24%	Within ±31%
	When the pump discharge pressure is less than 0.1 MPaG	0.03 MPa or less	0.03 MPa or less	0.035 MPa or less	0.045 MPa or less
	When the max capacity is reached (When the air tank (pressure vessel) separately described in the instruction manual is installed)	—	Within ±12.5% of the pump discharge pressure when it is 0.1 MPaG or more 0.03 MPa or less when the pump discharge pressure is less than 0.1 MPaG		
Operating temperature	°C	10 to 40 41 to 70 71 to 100	10 to 40 41 to 70 71 to 100	10 to 40 41 to 70 71 to 100	10 to 40 41 to 70 71 to 100
Supply air pressure	MPaG	0.2 to 0.4 0.2 to 0.3 0.2 to 0.25	0.2 to 0.3 0.2 to 0.25	0.2 to 0.3 0.2 to 0.25	0.2 to 0.3 0.2 to 0.25
Max discharge pressure	MPaG	0.35 0.25 0.2	0.25 0.2	0.25 0.2	0.25 0.2
Allowable differential pressure of bellows*2	MPa	0.3 0.25 0.2	0.3 0.25 0.2	0.3 0.25 0.2	0.3 0.25 0.2
Discharge capacity per stroke*3	L	0.03	0.1	0.2	0.4
Air consumption	L/min (Normal)	10 to 70	10 to 80	50 to 130	50 to 300
Ambient temperature	°C	10 to 50			
Air inlet ports	Pump drive side	2-Rc1/8	2-Rc1/4	2-Rc1/4	2-Rc3/8
	Master valve side	2-Rc1/4	2-Rc1/4	2-Rc1/4	2-Rc1/4
Weight	kg	Approx. 2.5	Approx. 7	Approx. 12	Approx. 21
Pump size (excluding piping)	A×E×H*4	mm 286×106 ^w ×111 ^h	330×138 ^w ×154 ^h	373×176 ^w ×181 ^h	449×210 ^w ×215 ^h

*1: To obtain performance with this pump, pipes with the pump connection size shown above are required. Install the pump so that the length of the suction pipe does not exceed two meters.

*2: Allowable differential pressure of bellows = Air supply pressure - Discharge pressure

*3: This is a reference value. Make sure that the stroke speed is always 100 spm or lower (120 spm or lower for the PS-E10MA).

*4: The pump size is a reference value.

Notes 1) If the fluid to be used requires anti-explosion treatment because it is an organic or similar liquid, anti-explosive pumps with proximity sensors are available. Please consult with us separately for more information.

2) If the fluid to be used is CMP slurry, we recommend the "PC series slurry pump" dedicated to use with CMP slurry.

■ Performance curve

H-Q characteristics — Air consumption - - - - -

Temperature: 20°C

• PS-E2MA •

Temperature: 80°C

Air supply piping size: $\phi 4 \times \phi 3 \times 2\text{m}$
 Fluid supply piping size: $\phi 10 \times \phi 8 \times 2\text{m}$ (on suction side) (Lift: 0.5 m) Fluid: Pure water
 $\phi 6 \times \phi 4$ (on discharge side)

Air supply piping size: $\phi 4 \times \phi 3 \times 2\text{m}$
 Fluid supply piping size: $\phi 10 \times \phi 8 \times 2\text{m}$ (on suction side) (Lift: 0.5 m) Fluid: Pure water
 $\phi 6 \times \phi 4$ (on discharge side)

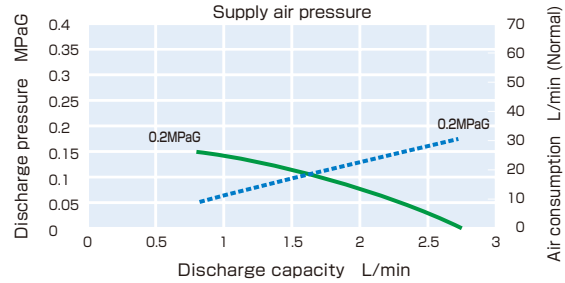
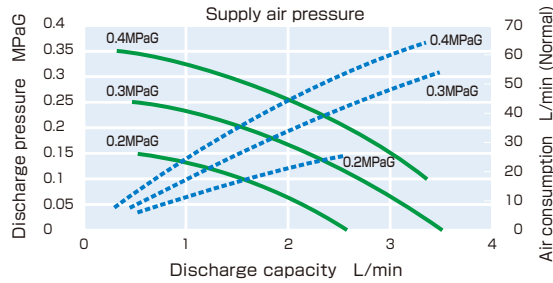

Temperature: 20°C

• PS-E10MA •

Temperature: 80°C

Air supply piping size: $\phi 6 \times \phi 4 \times 2\text{m}$
 Fluid supply piping size: $\phi 19 \times \phi 15.8 \times 2\text{m}$ (on suction side) (Lift: 0.5 m) Fluid: Pure water
 $\phi 12 \times \phi 10$ (on discharge side)

Air supply piping size: $\phi 6 \times \phi 4 \times 2\text{m}$
 Fluid supply piping size: $\phi 19 \times \phi 15.8 \times 2\text{m}$ (on suction side) (Lift: 0.5 m) Fluid: Pure water
 $\phi 12 \times \phi 10$ (on discharge side)

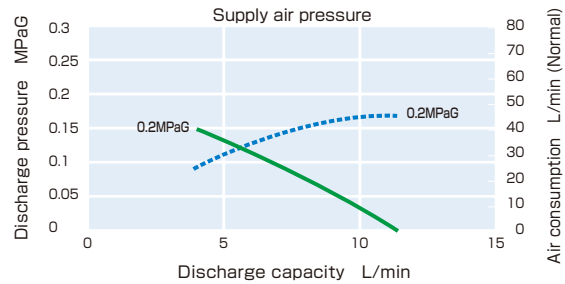
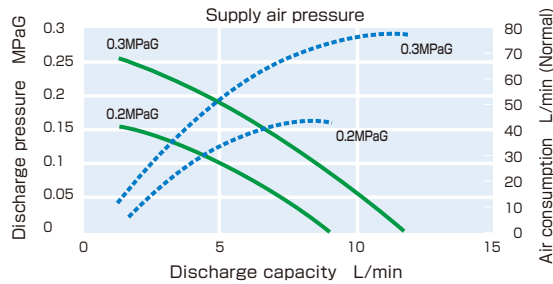

Temperature: 20°C

• PS-E20MA •

Temperature: 80°C

Air supply piping size: $\phi 8 \times \phi 6 \times 2\text{m}$
 Fluid supply piping size: $\phi 19 \times \phi 15.8 \times 2\text{m}$ (on suction side) (Lift: 0.5 m) Fluid: Pure water
 $\phi 19 \times \phi 15.8$ (on discharge side)

Air supply piping size: $\phi 8 \times \phi 6 \times 2\text{m}$
 Fluid supply piping size: $\phi 19 \times \phi 15.8 \times 2\text{m}$ (on suction side) (Lift: 0.5 m) Fluid: Pure water
 $\phi 19 \times \phi 15.8$ (on discharge side)

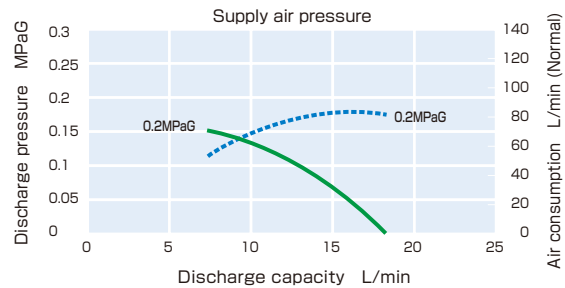
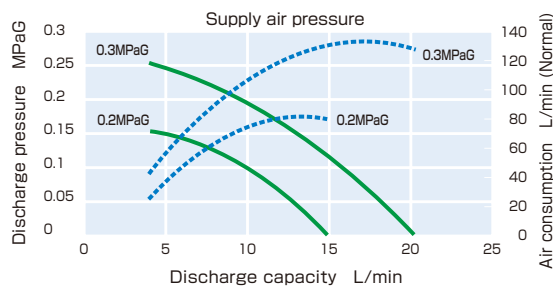

Temperature: 20°C

• PS-E40MA •

Temperature: 80°C

Air supply piping size: $\phi 12 \times \phi 10 \times 2\text{m}$
 Fluid supply piping size: $\phi 25 \times \phi 22 \times 2\text{m}$ (on suction side) (Lift: 0.5 m) Fluid: Pure water
 $\phi 25 \times \phi 22$ (on discharge side)

Air supply piping size: $\phi 12 \times \phi 10 \times 2\text{m}$
 Fluid supply piping size: $\phi 25 \times \phi 22 \times 2\text{m}$ (on suction side) (Lift: 0.5 m) Fluid: Pure water
 $\phi 25 \times \phi 22$ (on discharge side)

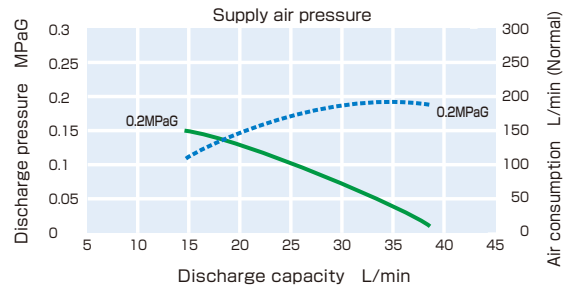
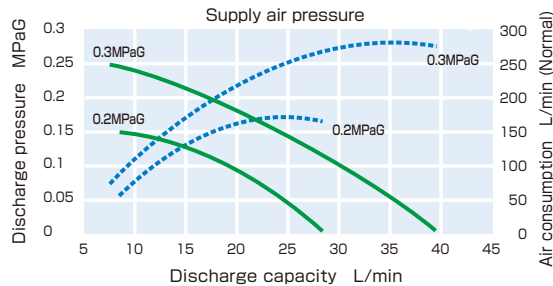

For cleaning system circulation line PS-E10H, PS-E20H, PS-E40H

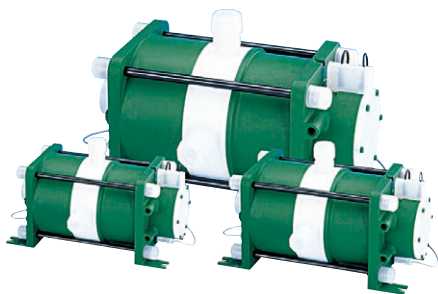

■ Dimensions

Unit: mm

	A	B	C	D	E	F	G	H	J	K	L	M
PS-E10H	330	285	163	188	138	112	183	154	74	Rc1/4	4-φ10	Rc1/4
PS-E20H	373	335	194	226	176	144	231	181	93	Rc1/4	4-φ12	Rc1/4
PS-E40H	449	395	245	316	210	172	277	215	110	Rc3/8	4-φ14	Rc1/4

■ Structural drawings

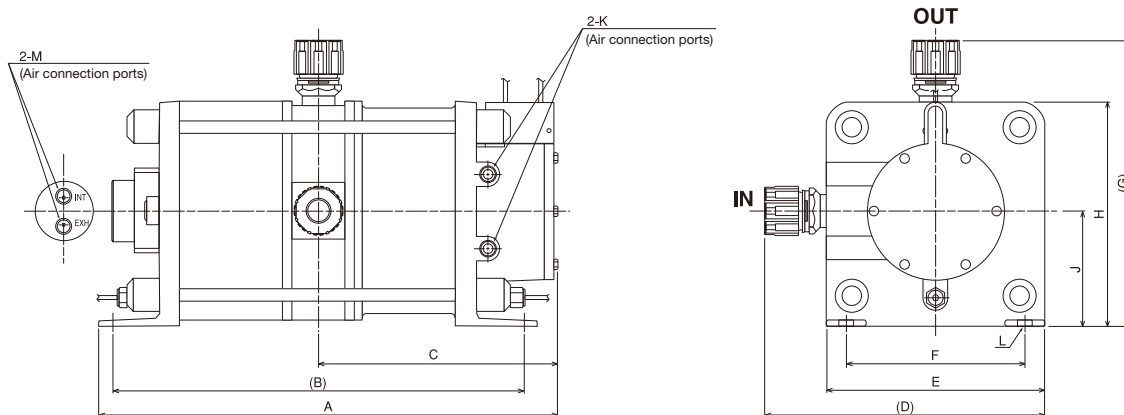

■ Specifications

Pump model		PS-E10H			PS-E20H			PS-E40H		
Pump connection size*1	mm	IN φ3/4" / OUT φ1/2"			IN φ3/4" / OUT φ3/4"			IN φ1-1/4" / OUT φ1"		
Pump connector		Super 300 Type Pillar Fitting™								
Max discharge capacity	L/min	10			20			40		
Pulsation pressure range	When the pump discharge pressure is 0.1 MPaG or more	Within ±16%			Within ±24%			Within ±31%		
	When the pump discharge pressure is less than 0.1 MPaG	0.03 MPa or less			0.035 MPa or less			0.045 MPa or less		
	When the max capacity is reached (When the air tank (pressure vessel) separately described in the instruction manual is installed)	Within ±12.5% of the pump discharge pressure when it is 0.1 MPaG or more 0.03 MPa or less when the pump discharge pressure is less than 0.1 MPaG								
Operating temperature	℃	10 to 40	41 to 100	101 to 180	10 to 40	41 to 100	101 to 180	10 to 40	41 to 100	101 to 160
Supply air pressure	MPaG	0.2 to 0.3	0.2 to 0.25	0.15 to 0.2	0.2 to 0.3	0.2 to 0.25	0.15 to 0.2	0.2 to 0.3	0.2 to 0.25	0.15 to 0.2
Max discharge pressure	MPaG	0.25	0.2	0.15	0.25	0.2	0.15	0.25	0.2	0.15
Allowable differential pressure of bellows*2	MPa	0.3	0.2	0.15	0.3	0.2	0.15	0.3	0.2	0.15
Discharge capacity per stroke*3	L	0.1			0.2			0.4		
Air consumption	L/min (Normal)	10 to 80			50 to 130			50 to 300		
Ambient temperature	℃	10 to 50								
Air inlet ports	Pump drive side	2-Rc1/4			2-Rc1/4			2-Rc3/8		
	Master valve side	2-Rc1/4			2-Rc1/4			2-Rc1/4		
Weight	kg	Approx. 7			Approx. 12			Approx. 21		
Pump size (excluding piping)	A×E×H*4	330 ^l ×138 ^w ×154 ^h			373 ^l ×176 ^w ×181 ^h			449 ^l ×210 ^w ×215 ^h		

*1: To obtain performance with this pump, pipes with the pump connection size shown above are required. Install the pump so that the length of the suction pipe does not exceed two meters.

*2: Allowable differential pressure of bellows = Air supply pressure - Discharge pressure

*3: This is a reference value. Make sure that the stroke speed is always 100 spm or lower (120 spm or lower for the PS-E10H).

*4: The pump size is a reference value.

Notes 1) If the fluid to be used requires anti-explosion treatment because it is an organic or similar liquid, anti-explosive pumps with proximity sensors are available. Please consult with us separately for more information.

2) If the fluid to be used is CMP slurry, we recommend the "PC series slurry pump" dedicated to use with CMP slurry.

■ Performance curve

H-Q characteristics ————— Air consumption - - - - -

Temperature: 100°C

• PS-E10H •

Temperature: 150°C

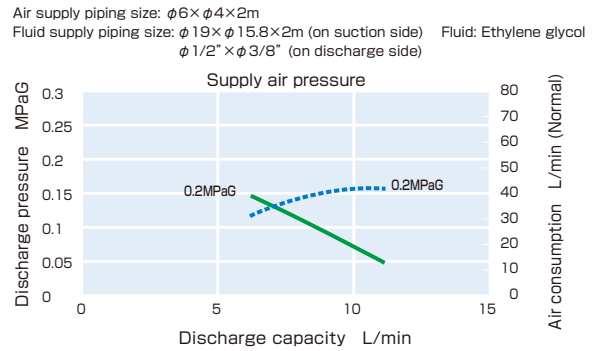
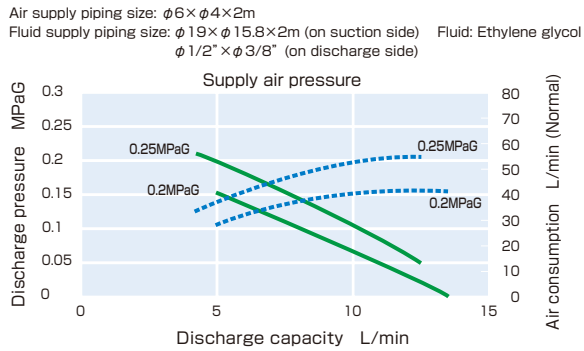

Temperature: 100°C

• PS-E20H •

Temperature: 150°C

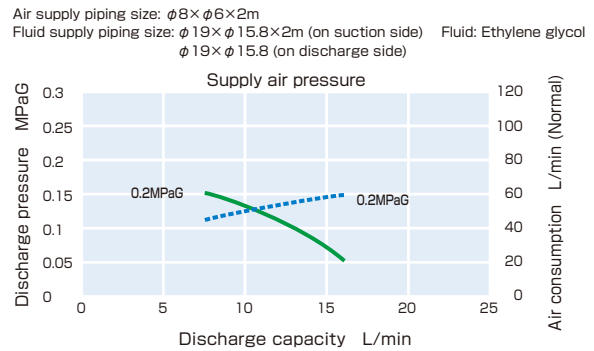
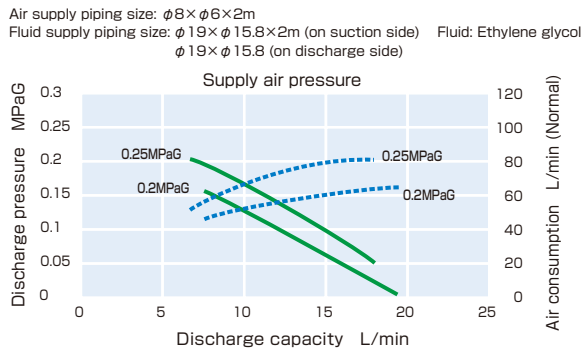

Temperature: 100°C

• PS-E40H •

Temperature: 150°C

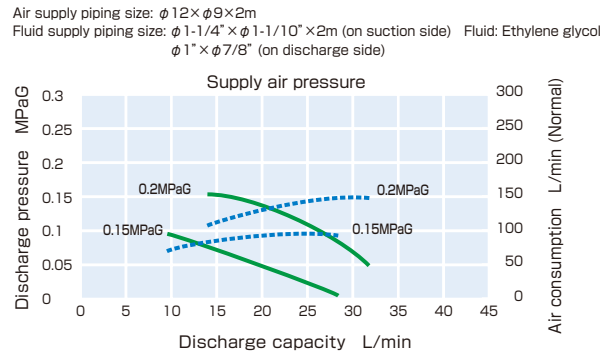
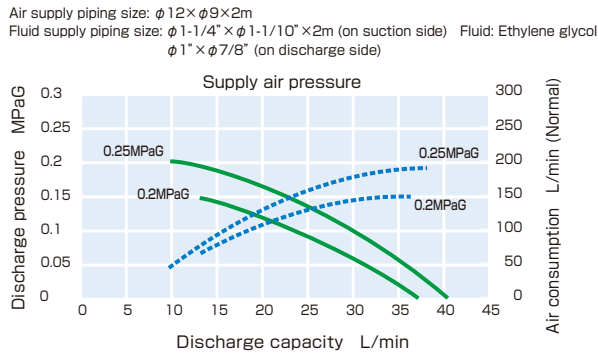

For liquid chemical supply line PS-10MA, PS-20MA, PS-30M, PS-40MA



Dimensions

Unit: mm

	A	B	C	D		E	F	G	H	J	K	L	M	N
				Super 300 Type	Flange									
PS-10MA	435	99	210	233	—	218	193	148	197	157	83	Rc1/4	4-M8	Rc1/4
PS-20MA	480	121	226	289	—	261	236.4	192	251	201	105	Rc3/8	4-M10	Rc1/4
PS-30M	521.4	434.4	252.4	331.5	—	231.4	161	124	312	239.4	123.7	Rc3/8	4-M12	Rc1/4
PS-40MA	544	164	266	—	383	335	300	255	326	264	136.5	Rc1/2	4-M12	Rc1/4
				IN / Flange connection	Super 300 Type									
PS-40MA	544	164	266	389	—	335	300	255	326	264	136.5	Rc1/2	4-M12	Rc1/4

Structural drawings

PS-10MA, PS-20MA, PS-40MA

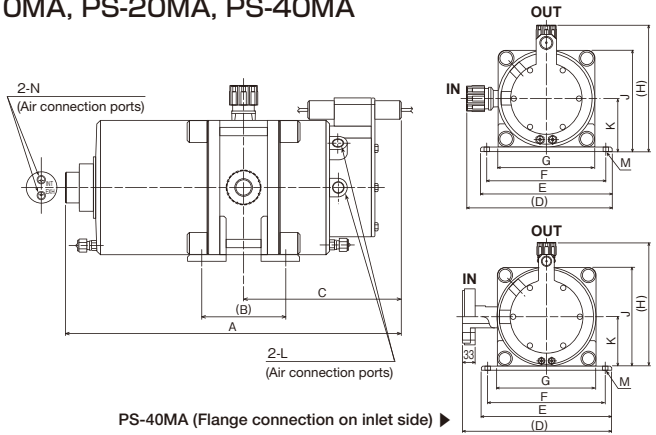

PS-30M

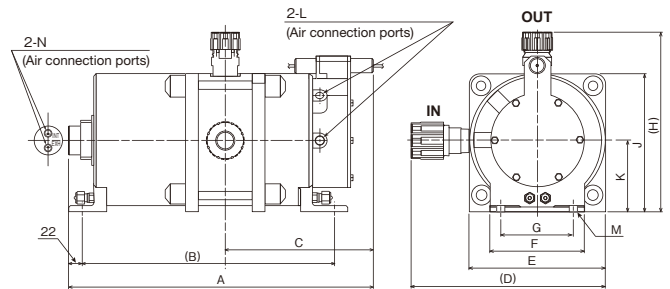

Specifications

Pump model		PS-10MA	PS-20MA	PS-30M	PS-40MA
Pump connection size*1	mm	IN ϕ 19 / OUT ϕ 12	IN ϕ 25 / OUT ϕ 19	IN ϕ 1-1/4" / OUT ϕ 25	IN JIS10K 32A or ϕ 1-1/2" / OUT ϕ 25
Pump connector*2		Super 300 Type Pillar Fitting™			
Max discharge capacity	L/min	12	24	35	48
Pulsation pressure range		Within \pm 12.5% of the pump discharge pressure when it is 0.1 MPaG or more 0.03 MPa or less when the pump discharge pressure is less than 0.1 MPaG			
Operating temperature	°C	10 to 40 / 41 to 70 / 71 to 100	10 to 40 / 41 to 70 / 71 to 100	10 to 40 / 41 to 70 / 71 to 100	10 to 40 / 41 to 70 / 71 to 100
Supply air pressure	MPaG	0.2 to 0.5 / 0.2 to 0.4 / 0.2 to 0.3	0.2 to 0.5 / 0.2 to 0.4 / 0.2 to 0.3	0.2 to 0.5 / 0.2 to 0.4 / 0.2 to 0.3	0.2 to 0.5 / 0.2 to 0.4 / 0.2 to 0.3
Max discharge pressure	MPaG	0.45 / 0.35 / 0.25	0.45 / 0.35 / 0.25	0.45 / 0.35 / 0.25	0.45 / 0.35 / 0.25
Allowable differential pressure of bellows*3	MPa	0.3 / 0.25 / 0.2	0.3 / 0.25 / 0.2	0.3 / 0.25 / 0.2	0.3 / 0.25 / 0.2
Discharge capacity per stroke*4	L	0.11	0.22	0.34	0.48
Air consumption	L/min (Normal)	50 to 150	80 to 270	95 to 310	100 to 420
Ambient temperature	°C	10 to 50			
Air inlet ports	Pump drive side	2-Rc1/4	2-Rc3/8	2-Rc3/8	2-Rc1/2
	Master valve side	2-Rc1/4	2-Rc1/4	2-Rc1/4	2-Rc1/4
Weight	kg	Approx. 10	Approx. 20	Approx. 32	Approx. 40
Pump size (excluding piping)	A×E×J*5	435 ^h ×218 ^w ×157 ^h	480 ^h ×261 ^w ×201 ^h	521.4 ^h ×231.4 ^w ×239.4 ^h	544 ^h ×335 ^w ×264 ^h

*1: To obtain performance with this pump, pipes with the pump connection size shown above are required. Install the pump so that the length of the suction pipe does not exceed two meters.

*2: The pump connector model differs according to the fitting type. Therefore, be sure to indicate the fitting type when placing an order.

*3: Allowable differential pressure of bellows = Air supply pressure - Discharge pressure

*4: This is a reference value. Make sure that the stroke speed is always 100 spm or lower (90 spm or lower for the PS-30M).

*5: The pump size is a reference value.

Notes 1) If the fluid to be used requires anti-explosion treatment because it is an organic or similar liquid, anti-explosive pumps with proximity sensors are available. Please consult with us separately for more information.

2) If the fluid to be used is CMP slurry, we recommend the "PC series slurry pump" dedicated to use with CMP slurry.

■ Performance curve

H-Q characteristics ————— Air consumption - - - - -

Temperature: 20°C

• PS-10MA •

Temperature: 80°C

Air supply piping size: $\phi 6 \times \phi 4 \times 2\text{m}$
 Fluid supply piping size: $\phi 19 \times \phi 15.8 \times 2\text{m}$ (on suction side) (Lift: 0.5 m) Fluid: Pure water
 $\phi 12 \times \phi 10$ (on discharge side)

Air supply piping size: $\phi 6 \times \phi 4 \times 2\text{m}$
 Fluid supply piping size: $\phi 19 \times \phi 15.8 \times 2\text{m}$ (on suction side) (Lift: 0.5 m) Fluid: Pure water
 $\phi 12 \times \phi 10$ (on discharge side)

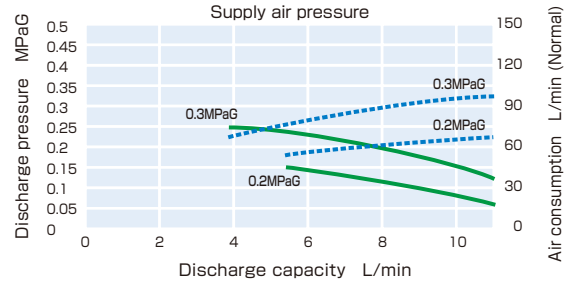
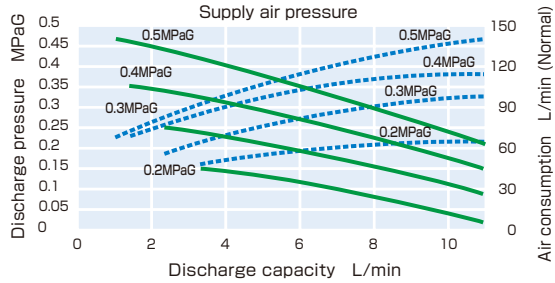

Temperature: 20°C

• PS-20MA •

Temperature: 80°C

Air supply piping size: $\phi 8 \times \phi 6 \times 2\text{m}$
 Fluid supply piping size: $\phi 25 \times \phi 22 \times 2\text{m}$ (on suction side) (Lift: 0.5 m) Fluid: Pure water
 $\phi 19 \times \phi 15.8$ (on discharge side)

Air supply piping size: $\phi 8 \times \phi 6 \times 2\text{m}$
 Fluid supply piping size: $\phi 25 \times \phi 22 \times 2\text{m}$ (on suction side) (Lift: 0.5 m) Fluid: Pure water
 $\phi 19 \times \phi 15.8$ (on discharge side)

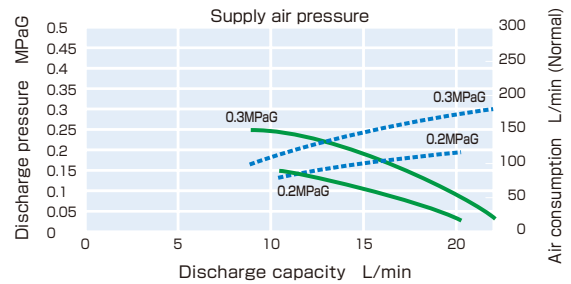
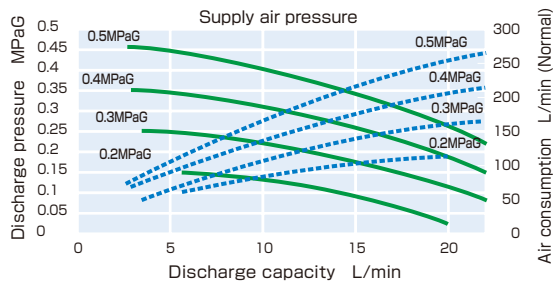

Temperature: 20°C

• PS-30M •

Temperature: 80°C

Air supply piping size: $\phi 8 \times \phi 6 \times 2\text{m}$
 Fluid supply piping size: $\phi 1-1/4" \times \phi 25 \times 2\text{m}$ (on suction side) (Lift: 0.5 m) Fluid: Pure water
 $\phi 25 \times \phi 22$ (on discharge side)

Air supply piping size: $\phi 8 \times \phi 6 \times 2\text{m}$
 Fluid supply piping size: $\phi 1-1/4" \times \phi 25 \times 2\text{m}$ (on suction side) (Lift: 0.5 m) Fluid: Pure water
 $\phi 25 \times \phi 22$ (on discharge side)

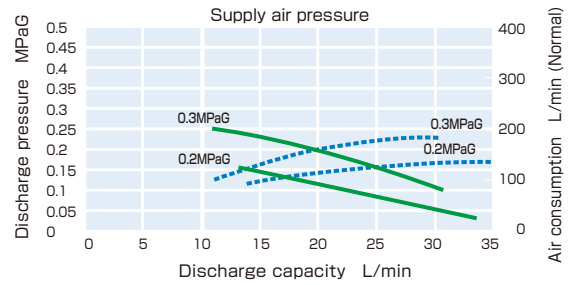
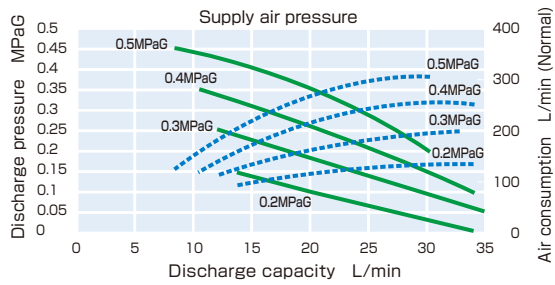

Temperature: 20°C

• PS-40MA •

Temperature: 80°C

Air supply piping size: $\phi 12 \times \phi 10 \times 2\text{m}$
 Fluid supply piping size: Rigid PVC pipe size 32 (on suction side) (Lift: 0.5 m) Fluid: Pure water
 $\phi 25 \times \phi 22$ (on discharge side)

Air supply piping size: $\phi 12 \times \phi 10 \times 2\text{m}$
 Fluid supply piping size: Rigid PVC pipe size 32 (on suction side) (Lift: 0.5 m) Fluid: Pure water
 $\phi 25 \times \phi 22$ (on discharge side)

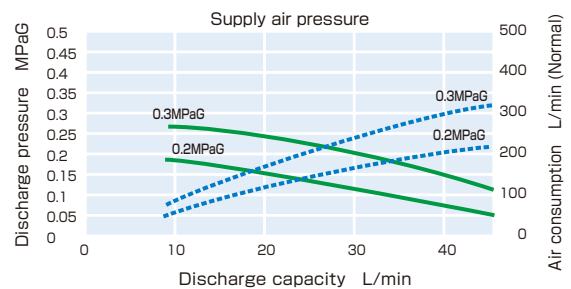
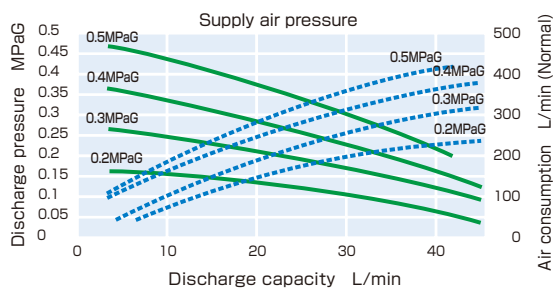

Example of use in a semiconductor factory

Pillar products such as pumps, fittings, and valves are widely used in semiconductor and LCD factories.

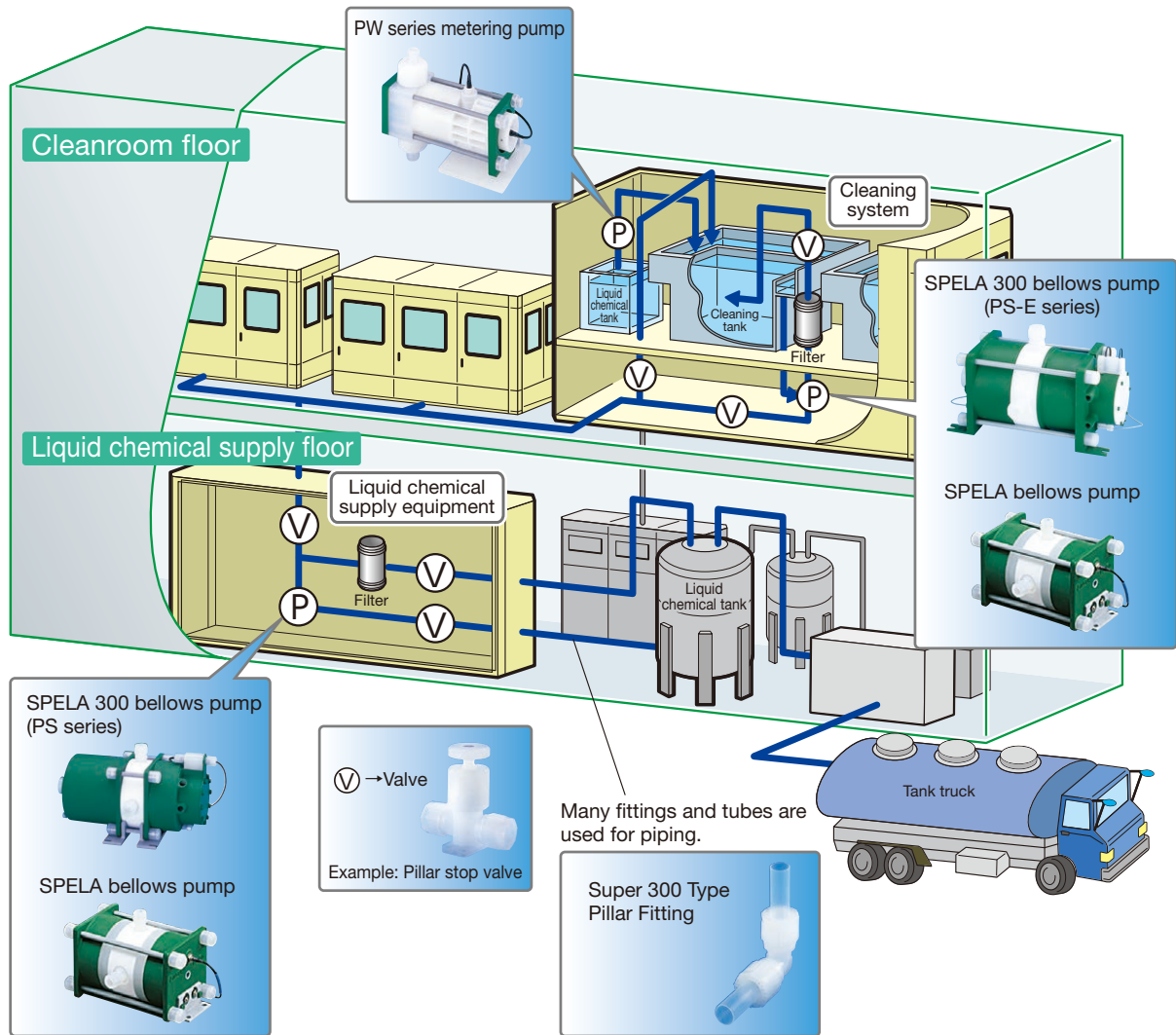

PILLAR NIPPON PILLAR PACKING CO., LTD.

Head office/Sales Headquarters
7-1, Shinmachi 1-chome, Nishi-ku, Osaka 550-0013, Japan
Phone: +81-6-7166-8326 Fax: +81-6-7166-8514

Email : sales@pillar.co.jp

<https://www3.pillar.co.jp/en/product/>



Safety precaution

● When using this product, please use correctly and pay sufficient attention to safety.

* Please understand that this catalog may change without prior notice.
* The values shown on this catalog are reference values, not guaranteed values.